

**Bloxx**

**ECORASTER®**



Please read the manual



Please wear head protection



Please wear goggles



Please wear gloves



Please wear safety shoes



Maximum stack 2 pallets



Please stack pallets straight



Don't breathe fumes

1

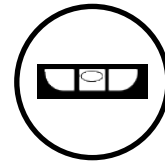
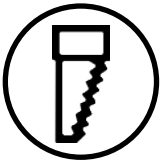
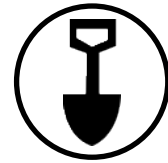
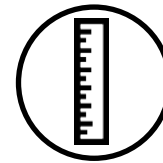
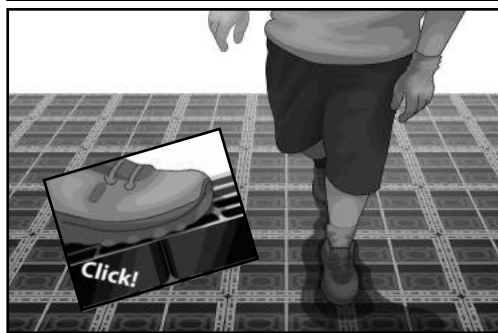
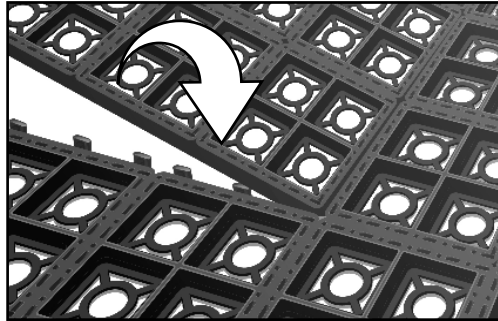
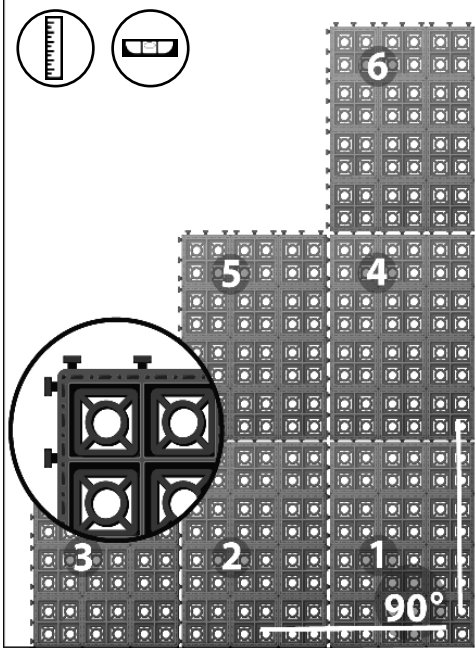

2

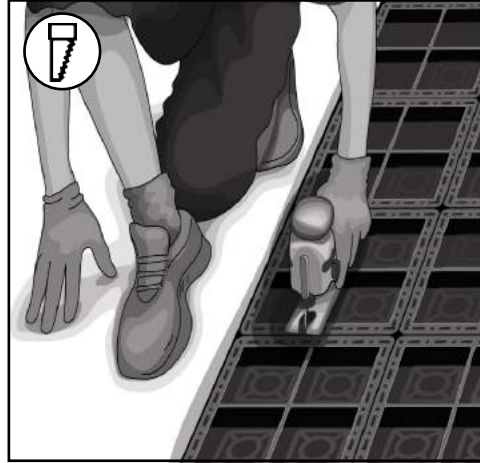
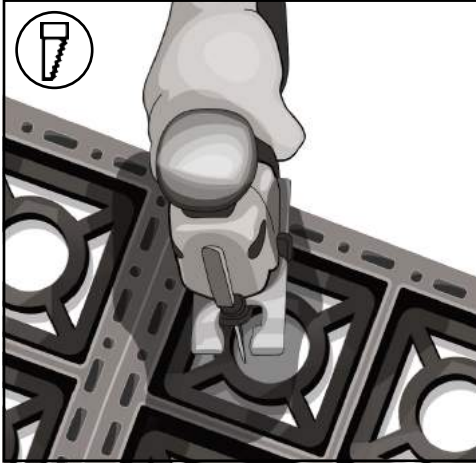

3

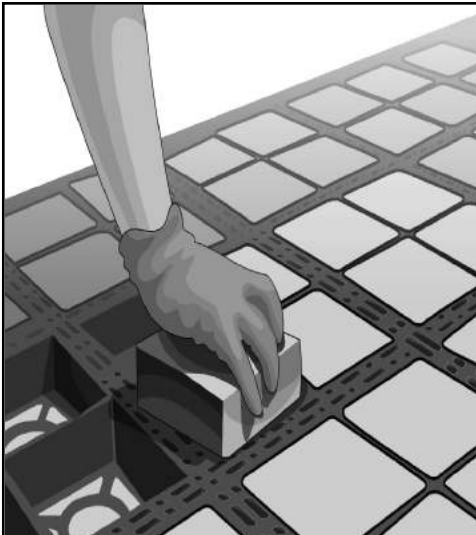

4



Tel: +43 660 329 21 21



gerhard@storke.at



www.ecoraster.storke.at



STORKE Baupartner  
Lindenweg 3  
AT-4081 Hartkirchen

**NOTE**

a. Efflorescence are part of a natural process. They may appear but do not constitute a technical defect. Please note our technical information on [www.ecoraster.com](http://www.ecoraster.com)  
b. Please note the installation instructions on our website! Subject to change without prior notice. E. & O.E.  
c. ECORASTER® is a PURUS PLASTICS GmbH brand.